

INNOVATIVE DINING FURNITURE FOR EDUCATION ENVIRONMENTS



WELCOME TO VERSA

Flexible and space-efficient furniture for multi-use environments.

Whether you are looking to solve problems with the lack of space or simply trying to increase your dining capacity, we have the answer for you.

Westcountry Group is an innovative, design-led and client-centric refurbishment, fit-out and furniture company. We have worked in the education sector for over 45 years, helping various institutions create an effective dining and learning experience. Our versatile fixed and mobile tables help you maximise space and deliver flexibility without the need for expensive construction or large unmanageable furniture.

Our Versa range of mobile folding tables is the perfect solution for primary, secondary, college and university education settings. We have experience in creating the most optimised dining space to suit your own specific requirements.

We offer a full space-planning and design service as part of the process, or you can even customise your tables with your own graphics or branding if you wish. Either way, we will help you visualise your furniture from concept through to completion.



CONTENTS

WALL POCKET	04
BENCHMARK	08
HALLMARK	12
CONVERTABLES	18
CUSTOMISATION & COLOUR OPTIONS	22
BESPOKE DESIGNS	24
SERVICE & MAINTENANCE	26



WALL POCKET

The world's most space-efficient dining table system

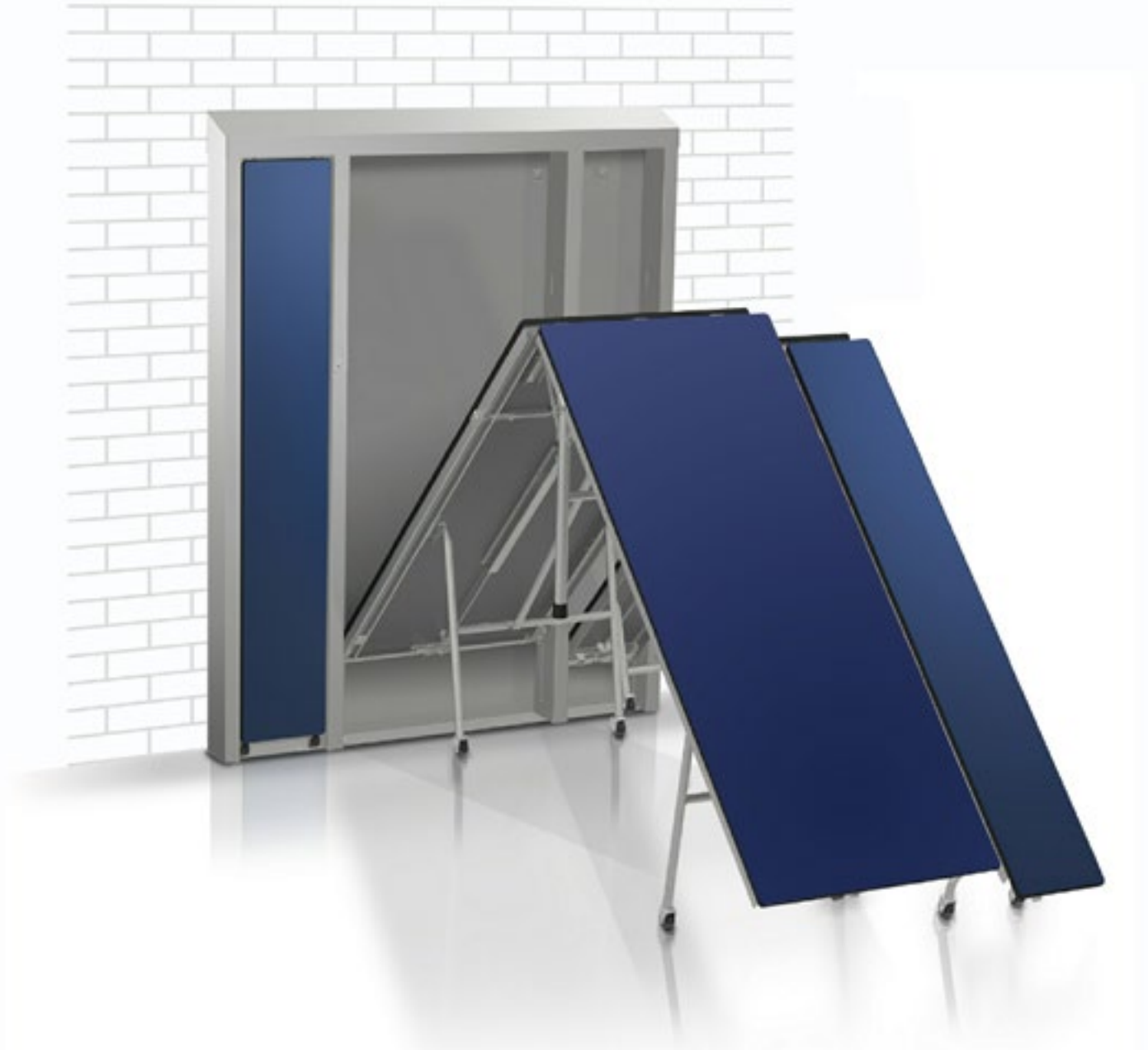

OUR LEGENDARY SPACE SAVER

The Wall Pocket system is the perfect answer for pupil dining in multi-purpose halls. When the tables are stored away, you can utilise the space as required, but when needed you can remove the tables and benches from the wall and set up in no time at all.

Having this flexibility is the perfect answer where floor space and storage are at a premium. Think of it like an extension without the need for planning permission! The storage area that once held your dining furniture is now empty and can be used for PE equipment or even a new space for learning. The benefit is, you can fit more students in without the need for extra furniture.

The Wall Pocket comes as a recessed version that sits flush within the hall wall or surface-mounted that is fixed to an existing wall. They come in a variety of colours and laminates and can also be customised with images or your logo which has proved to be popular with students.

 Your hall dining capacity is increased whilst using less space

 It only takes 8 minutes for one person to layout our Wall Pockets for lunch, seating 240 pupils



We are now able to easily seat our whole school for mealtimes, and the children seem to respect and take greater care over them because they look so smart.

Headteacher



KEY FEATURES & BENEFITS



MULTI-USE FLEXIBILITY

Wall Pocket's ease of use enables your hall to be used for other activities for longer every day



EASY TO SETUP

Wall Pocket speeds up room set-up time allowing meal-time staff more time to supervise and monitor pupils during lunch



QUIETER AND SAFER ENVIRONMENT

Wall Pocket removes the noise and safety risks associated with loose chairs, improving the safety and wellbeing of pupils in your dining hall



MULTIPURPOSE CONFIGURATIONS

The independent benches allows your hall to be easily reconfigured for assemblies, as a lecture theatre or an additional classroom in minutes



CUSTOMISATION

The tables are available in a variety of frame, bench, and surface colour options, or you customise them with images or logos of your choice



WHEELCHAIR ACCESS

Choice of tables with access for wheelchairs



They are a great idea, they pack away in no time and I think most schools should have them - great product.

Site Manager



A SPACE EFFICIENT SOLUTION FOR KEHELLAND VILLAGE SCHOOL

Westcountry Group installed three single customised Wall Pocket dining systems in their multi-use hall, delivering seating for up to 60 students. The school chose a unique colour for the Wall Pocket case to match the school's colour scheme. The clean, professional, and modern look of these tables really sets this hall apart from other schools in the area, making many quite envious!

ADDITIONAL BENEFITS

- ✓ Wall mounted and recessed options available
 - ✓ Ultra-durable and hygienic table and bench surfaces
 - ✓ Available in a wide range of frame, table and bench colours - see page 22
 - ✓ Custom print the tables for your own piece of wall art - image or logo of your choice
 - ✓ Shorter 3.6mtr Wall Pocket system also available, please enquire for more information
 - ✓ The Wall Pocket system is covered by a free lifetime warranty, when a service and maintenance contract is agreed at the time of order
- Optional Extra**
- ✓ 360 degree multi-directional wheels available - ask for more information



For years we have had student capacity issues at lunchtime. At the Schools and Academies show last year we discovered the Wall Pocket system and we couldn't be more pleased with them.

Principal, St Thomas Aquinas School

TECHNICAL INFORMATION

All dimensions given are approximate.

POCKET DEPTH

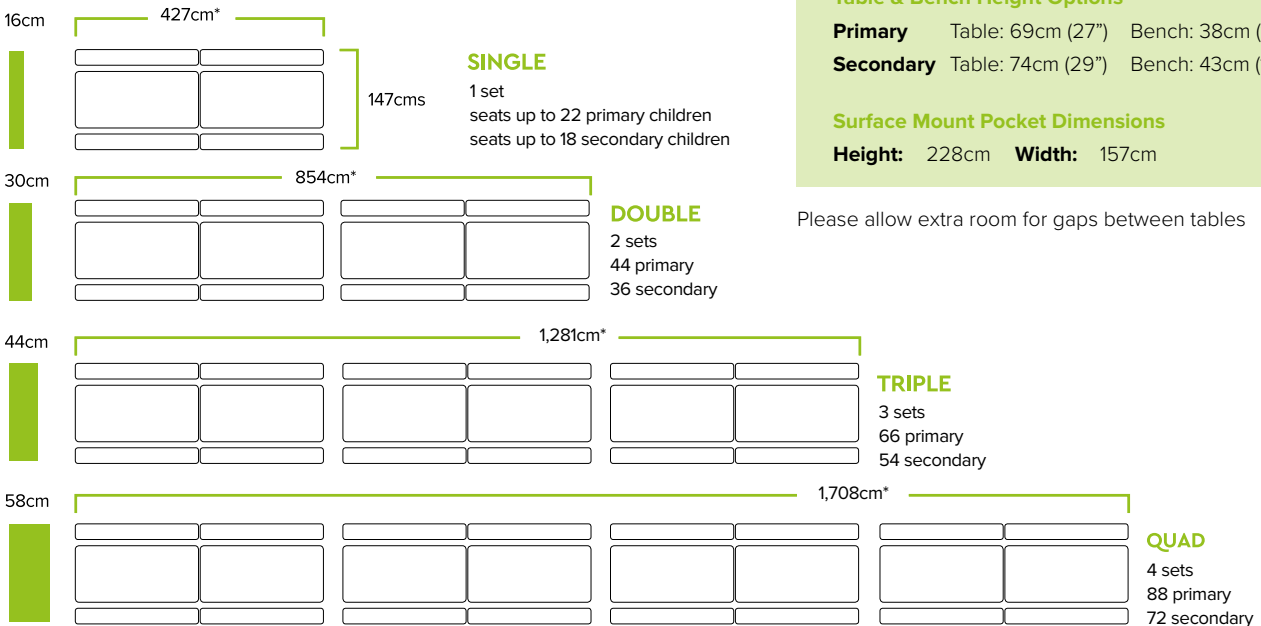

Table & Bench Height Options

Primary Table: 69cm (27") Bench: 38cm (15")

Secondary Table: 74cm (29") Bench: 43cm (17")

Surface Mount Pocket Dimensions

Height: 228cm **Width:** 157cm

Please allow extra room for gaps between tables

*Excluding gaps between tables.

BENCHMARK

Stores in 44% less space than standard folding dining tables



SPACE-EFFICIENT MOBILE DINING FURNITURE

The Benchmark table is one of the most space-efficient mobile tables in the world.

The ultra slim / compact design offers adjustable table heights accommodating your everyday dining needs for primary schools, secondary schools and colleges.

The Benchmark is an industry leader in compact storage - six tables require a footprint of less than 1.6m x 2.24m, with each additional table adding just 28cm to the nested depth. With the Benchmark, space optimisation comes as standard.

The extended tabletops offer extra room per student and end-to-end positioning with no gaps between tables. When you experience Benchmark for the first time, you will understand why it's the most space efficient table available.



Over 100 standard colour options



We love our Benchmarks; at last we can get all of our dining furniture into our store



For years we have had student capacity issues at lunchtime. We came across the Benchmark tables and we haven't looked back since. We couldn't be more pleased with them.

Principal



KEY FEATURES & BENEFITS



COMPACT STORAGE

Six Benchmark tables require a footprint of less than 1.6m x 2.24m with each additional table adding just 28cm



CUSTOMISATION

Why not customise each table with an image or logo of your choice



EASY TO SETUP

The lift assist system provides a smooth controlled operation during setup



SAFER DINING

Anti-glide legs and DoubleGuard anti-tipping feet provides stability in both the down and upright positions



INCREASED DINING CAPACITY

You can fit more Benchmark tables in your storage area, providing more capacity in your hall for other resources



WHEELCHAIR ACCESS

Choice of tables with access for wheelchairs



We find them extremely good value for money. They are a quality product and I would thoroughly recommend the Benchmark tables to anyone.

Trust Business Manager

A COMPACT, DURABLE RESULT AT WESTCLYST PRIMARY ACADEMY

Westclyst Primary Academy chose the Benchmark tables because they provided exceptional value for money, they liked the quality design and they have been very popular with their staff and students. They also liked that the tables came with a reassuring 15-year warranty giving them complete peace of mind.

ADDITIONAL BENEFITS

- ✔ Ultra-durable hygienic table and bench surfaces
- ✔ Three different table lengths to choose from and each table extends beyond the bench for comfort
- ✔ Table top can be height adjusted to either 69cm, 74cm or 76cm
- ✔ Tamper-proof and moisture resistant polyurea edging ensures longevity
- ✔ Fusion Maple laminate tables in stock and available within 5 working days
- ✔ Available in a wide range of frame, table and bench colours - see page 22
- ✔ The Benchmark tables are covered by a free lifetime warranty, when a service and maintenance contract is agreed at the time of order



Westcountry Group helped us deliver a smart and efficient solution that solves capacity issues and reinforces the culture of the school. I would wholeheartedly recommend them.

Principal

TECHNICAL INFORMATION

All dimensions given are approximate.

MODELS

Model Number	Seating Capacity Children/Adults	Seat Height	Table Height	Approx. Storage Height
V19F273008	12/8	43cm	69cm	131cm
V19F293008	12/8	43cm	74cm	131cm
V19F303008	12/8	43cm	76cm	131cm

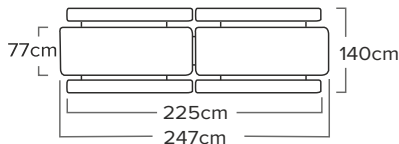

Model Number	Seating Capacity Children/Adults	Seat Height	Table Height	Approx. Storage Height
V19F273010	14/10	43cm	69cm	162cm
V19F293010	14/10	43cm	74cm	162cm
V19F303010	14/10	43cm	76cm	162cm

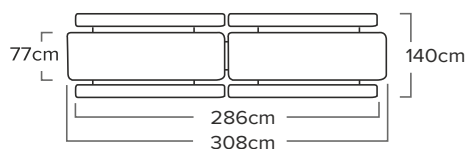

Model Number	Seating Capacity Children/Adults	Seat Height	Table Height	Approx. Storage Height
V19F273012	16-20/12	43cm	69cm	192cm
V19F293012	16-20/12	43cm	74cm	192cm
V19F303012	16-20/12	43cm	76cm	192cm

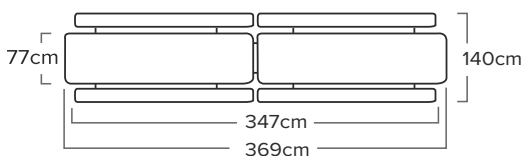

HALLMARK

The perfect solution
for any educational
environment



FLEXIBLE SPACE-EFFICIENT DINING

Hallmark tables are the ultimate in flexible space-efficient dining in education environments.

You can choose from a variety of models and options for a varied and inspiring dining experience. Including options of stools and/or mini-benches, wheelchair-accessible models, two height options and hundreds of frame, table and stool finishes to cater for a variety of needs. You can even customise your tables with your own images or logo!

The Hallmark tables fold up neatly and securely and can be manoeuvred around easily courtesy of the large wheels. This provides you with an easy set-up and put away solution. They are ideal for all educational environments from primary to secondary through to colleges and universities.

> Accessible models providing access for two to four wheelchairs

“ We love our Hallmark tables so easy to manoeuvre and store



In the past we have struggled with student capacity at lunchtime. Our Hallmark tables have solved these issues, and they are so easy to setup and put away. I would recommend them to anyone.

Catering Manager



KEY FEATURES & BENEFITS



EASY TO USE

Dual-spring mechanism and easy glide wheels make Hallmark tables one of the easiest dining tables to setup



WHEELCHAIR ACCESS

Choice of tables with access for wheelchair users and standard seating



CUSTOMISATION

Why not customise each table with an image or logo of your choice



SAFER DINING

Stability in both down and upright positions, thanks to dual locking latches and anti-glide legs. Stools are mounted on steel plates for maximum safety and durability



FLEXIBILITY

Mix and match from the huge range of options for the best use of your dining space. Options on table shape, height and colour, seat configuration and colour, and frame finish



They are quick and easy to use and can be setup by all staff members, which has provided a seamless lunchtime experience.

Business Manager



COMPACT AND EASY TO USE SOLUTION PRIMARY SCHOOL

Our new tables have been a big asset to us. They have increased the number of pupils we can sit at mealtimes and our staff no longer have to carry or set up heavy tables. This has increased morale and reduced the risk of injury.



We are extremely pleased with the Hallmark tables they are quick and easy to use. It has created more space in the dining hall and we are really pleased with how they look.

Catering Manager



ADDITIONAL BENEFITS

- ✓ Ultra-durable hygienic table and bench surfaces
- ✓ Different table heights available along with a choice of size, shape and seating configurations to meet your needs
- ✓ Tamper-proof and moisture resistant polyurea edging ensures longevity
- ✓ Heavy gauge steel plates secure stools at four points. No more broken stools!
- ✓ Available in a wide range of frame, table, bench and stool colours - see page 22/23
- ✓ The Hallmark tables are covered by a free lifetime warranty, when a service and maintenance contract is agreed at the time of order



We know with Westcountry Group that you always get good quality products and great customer support. Their product range often offers something different to the norm.

School Governor

TECHNICAL INFORMATION

All dimensions given are approximate.

 Suitable for wheelchair users

MODEL NUMBER	SEATS	TABLE & SEAT HEIGHT
V59T3260RDB2S2*WC	6 + 2WC	81/51cm

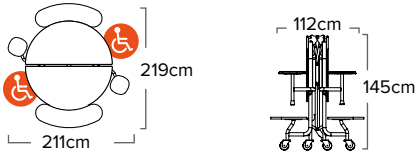

MODEL NUMBER	SEATS	TABLE & SEAT HEIGHT
V59T275263-S8	8	69/38cm
V59T295263-S8	8	74/43cm

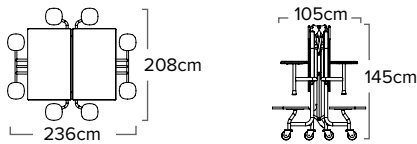

MODEL NUMBER	SEATS	TABLE & SEAT HEIGHT
V59T2760EL-S8	8	69/38cm
V59T2760EL-B2S4	8	69/38cm

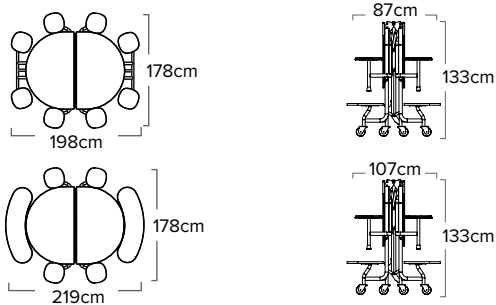

MODEL NUMBER	SEATS	TABLE & SEAT HEIGHT
V59T27120ELS12	12	69/38cm
V59T29120ELS12	12	74/43cm
V59T29120ELS10*WC	10 + WC	74/43cm

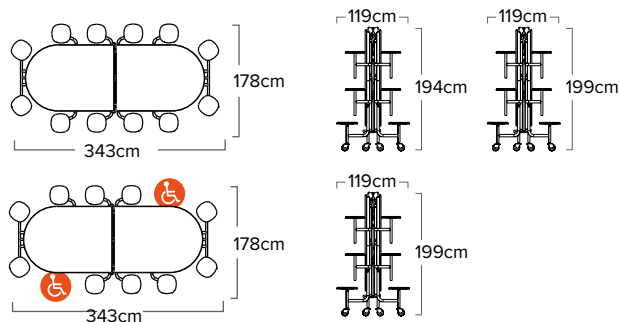

MODEL NUMBER	SEATS	TABLE & SEAT HEIGHT
V59T2760RD-B4	8	69/38cm
V59T2960RD-B4	8	74/43cm

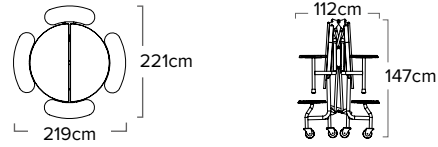

MODEL NUMBER	SEATS	TABLE & SEAT HEIGHT
V59T3260RD-S6*WC	6 + 2WC	81/51cm

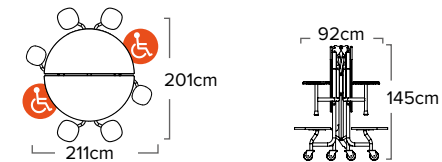

MODEL NUMBER	SEATS	TABLE & SEAT HEIGHT
V60T273008-S08	8	69/38cm
V60T293008-S08	8	74/43cm

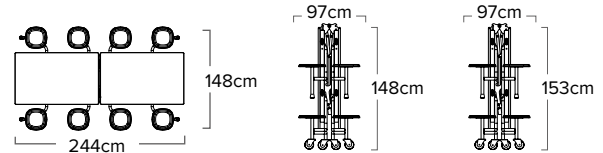

MODEL NUMBER	SEATS	TABLE & SEAT HEIGHT
V59T2760RD-S8	8	69/38cm
V59T2960RD-S8	8	74/43cm

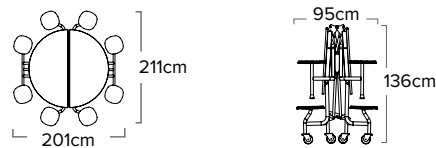

MODEL NUMBER	SEATS	TABLE & SEAT HEIGHT
V59T2760RDB2S4	8	69/38cm
V59T2960RDB2S4	8	74/43cm

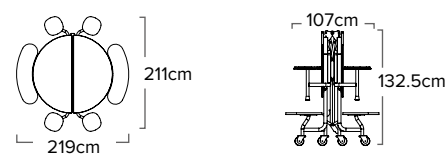

All dimensions given are approximate.

 Suitable for wheelchair users

MODEL NUMBER	SEATS	TABLE & SEAT HEIGHT
V59T2760OC-S8	8	69/38cm
V59T2960OC-S8	8	74/43cm

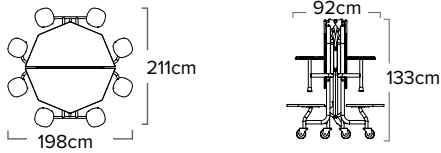

MODEL NUMBER	SEATS	TABLE & SEAT HEIGHT
V59T275263-B2S4	8	69/38cm
V59T295263-B2S4	8	74/43cm

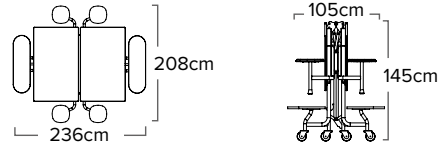

MODEL NUMBER	SEATS	TABLE & SEAT HEIGHT
V60T253010-S12	12	64/38cm
V60T273010-S12	12	69/38cm
V60T293010-S12	12	74/43cm

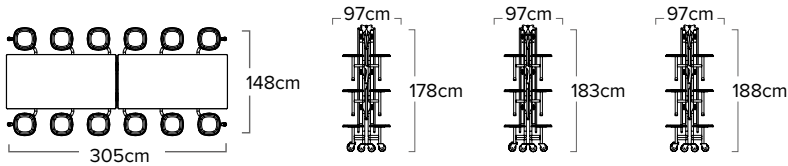

MODEL NUMBER	SEATS	TABLE & SEAT HEIGHT
V60T273012-S12	12	69/38cm
V60T293012-S12	12	74/43cm
V60T303012-S08*WC	8 + 2WC	76/46cm

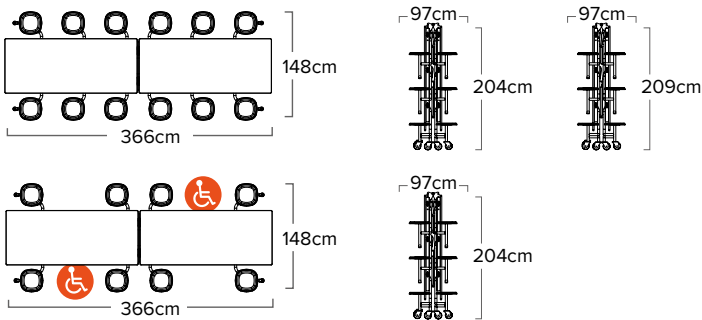

MODEL NUMBER	SEATS	TABLE & SEAT HEIGHT
V60T253012-S16	16	64/38cm
V60T273012-S16	16	69/38cm
V60T293012-S16	16	74/43cm

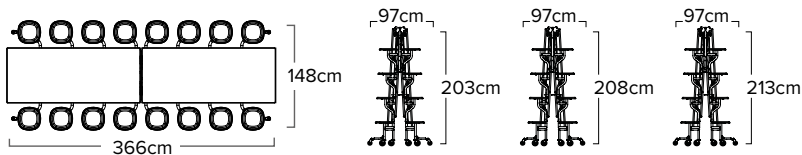

CONVERTABLES

The ultimate
'do anything'
dining solution



FLEXIBLE FURNITURE FOR FLEXIBLE SPACES

Whether you want your hall to be a dining hall, a lecture room, or an auditorium, our ConverTables are the answer.

These mobile tables easily transform from a single-sided lecture table, to a useful bench, to a full-sized dining table in no time at all. They are easy to manoeuvre and store neatly in a minimum amount of space. Their robust design ensures they will stand up to the rigours of education and the 15-year warranty gives complete peace of mind.

 **Smaller leg footprint with clear walkaway access**

 **A table that does three jobs in one, what an asset to have in your school**



Having a set of tables that does three jobs and takes up the minimum amount of storage has been invaluable to us. They are really easy to setup and gives us the flexibility when we need it.

Headteacher



KEY FEATURES & BENEFITS



VERSATILE

Transform from a single-sided table to a bench table or a full-size dining table



COST-EFFECTIVE

One table does three jobs and takes up the minimum amount of storage



SAFE AND STABLE

Eight points of floor contact including four seat-support legs on the most popular 2.4m version



SEATING WITH BACKREST

Transforms from a single-sided table to seating with a backrest, suitable for assemblies and lectures



SECURE

The safety latch is located under the tabletop hidden away - out of the sight of students



CUSTOMISABLE

ConverTables can be fully customised with a graphic of your choice; liven up your hall and give your table its own identity



What a great idea! These tables pack away in no time and they are really easy to store - great product.

Headteacher

COMPACT AND DURABLE RESULT

The ConverTables have proven to be the perfect answer for schools across the country. These versatile tables are an ideal solution for education settings that are looking for multi-use furniture, for different activities throughout the day.

ADDITIONAL BENEFITS

- ✔ Ultra-durable hygienic table and bench surfaces
- ✔ Different table heights to choose from along with a choice of widths and seating configurations to meet your needs
- ✔ Tamper-proof and moisture resistant polyurea edging ensures longevity
- ✔ Available in a wide range of frame, table and bench colours - see page 22
- ✔ The ConverTables are covered by a free lifetime warranty, when a service and maintenance contract is agreed at the time of order

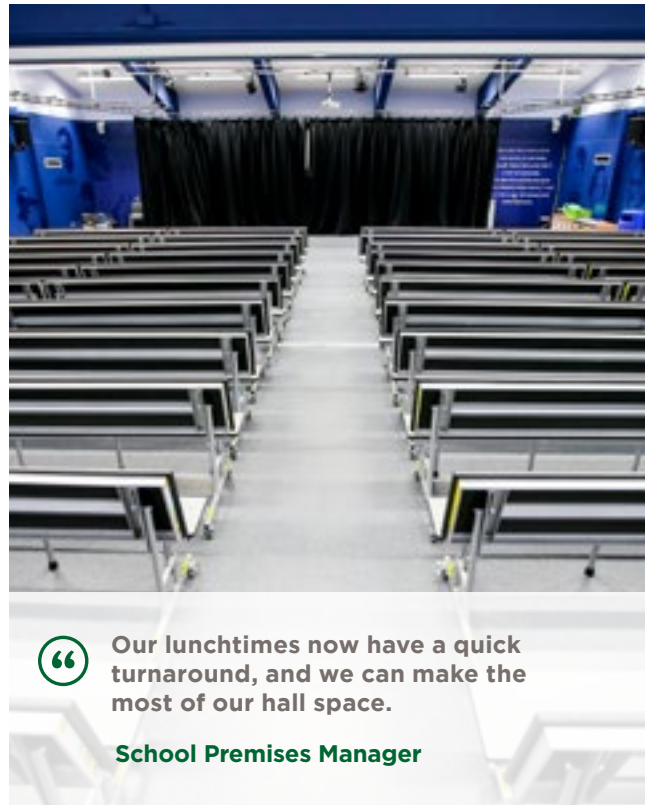

KEY FEATURES & BENEFITS

All dimensions given are approximate.

MODELS

Model Number	Seating Capacity Children/Adults	Table & Bench Height
V34M251504	3/2	64cm/38cm
V34M271504	3/2	69cm/38cm
V34M291504	3/2	74cm/38cm

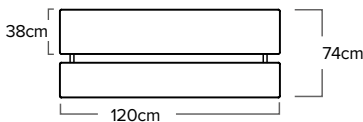

Model Number	Seating Capacity Children/Adults	Table & Bench Height
V34M251506	4/3	64cm/38cm
V34M271506	4/3	69cm/38cm
V34M291506	4/3	74cm/38cm



Model Number	Seating Capacity Children/Adults	Table & Bench Height
V34M251508	6/4	64cm/38cm
V34M271508	6/4	69cm/38cm
V34M291508	6/4	74cm/38cm

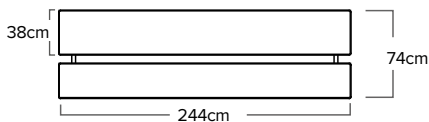

CUSTOMISATION AND COLOUR OPTIONS

LAMINATES FOR TABLES AND BENCHES

Choose from over 160 colours, one of the largest ranges available today. A selection is shown below, and a colour chart is available on request.

Our most popular laminate colours are as follows:



Other laminate colours available include:

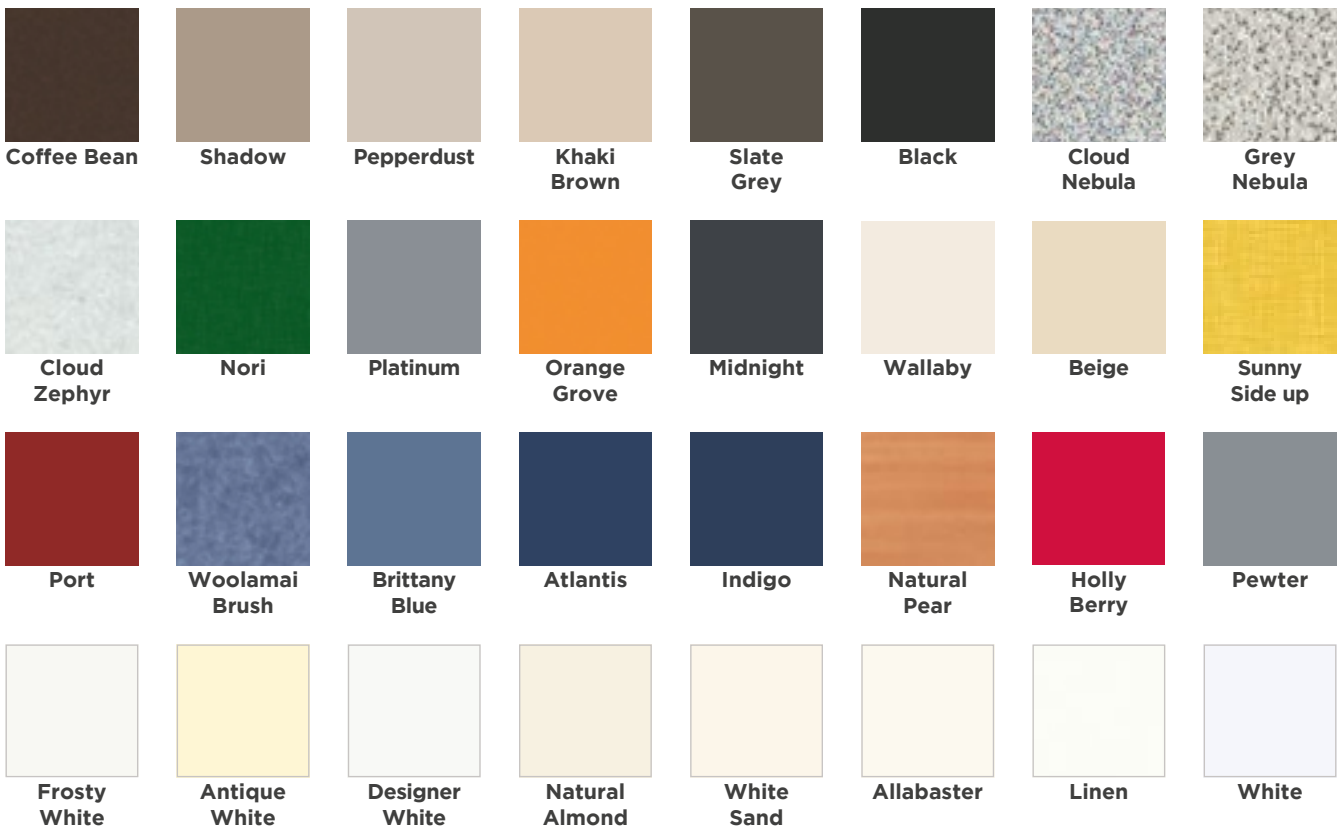

STOOLS

Versa's dining table stools are available in a wide range of colours - shown below:



TABLE FRAME OPTIONS

You can choose between three standard frame finishes - see below:



Please note, colours may vary from actual product.

BESPOKE DESIGNS

CUSTOMISED TABLES AND BENCHES

All our dining furniture is fully customisable allowing you to add your logo or preferred image to your order, bringing life to your dining hall or cafeteria. This has proven to be very popular with our customers and particularly students.

Your customised design is incorporated into the laminate making it durable and therefore able to withstand a busy school environment. You simply send us your logo or preferred image and we will create a sample for your approval.

Please note: there is an additional charge for this service, but no minimum order quantity required.

Please contact us for more information.





SERVICE AND MAINTENANCE



All our tables are covered by a standard 15 year manufacturer's warranty and tables are guaranteed to be free from defects in original material and workmanship for the number of years specified.

It is also important that your furniture meets all the necessary legal requirements and standards (PUWER) particularly around health and safety (HSE) and work equipment regulations.

To help, we offer a dining furniture annual maintenance and servicing plan for all our tables as well as those you may have from other providers. We will visit you and carry out all essential safety checks and do a thorough inspection giving you complete peace of mind and reassurance.

Whilst on site, our technicians will lubricate all moving parts, make any necessary adjustments and complete functionality checks to make sure you get the full use and life from your tables.

You can extend to a free lifetime warranty with our service and maintenance contract, or we can tailor a maintenance plan to suit your needs.

Please contact us for more information.





**READY TO
TRANSFORM YOUR
ENVIRONMENT?**

Call us on

0330 030 0330



GET IN TOUCH

Head Office
Cranmere House
Darklake View
Plymouth
PL6 7TW

T: 0330 030 0330
E: ideas@versadesign.co.uk
W: www.versadesign.co.uk

South East Office
Warne House
Central Way
Walworth Industrial Estate
Andover
SP10 5AN



If dialling internationally please call +44 1752 696300

